

Universal Testing Machine

Accessories & Fixtures

Screw type parallel jaw grip

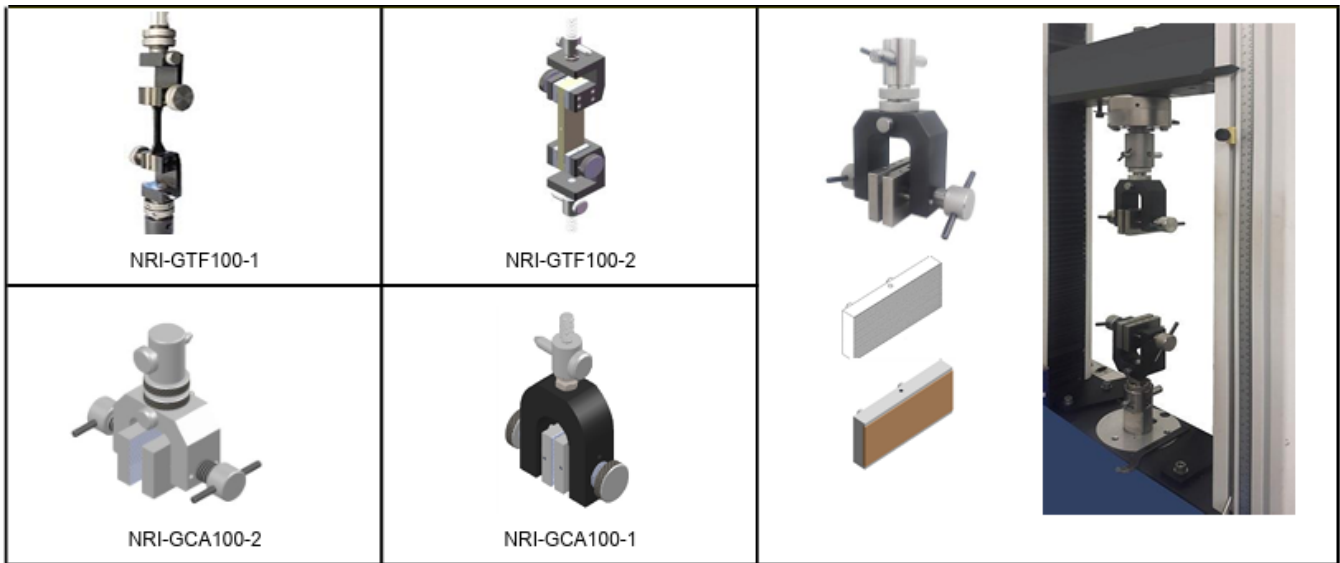

Wire & cord grip



Rubber & Plastic grip

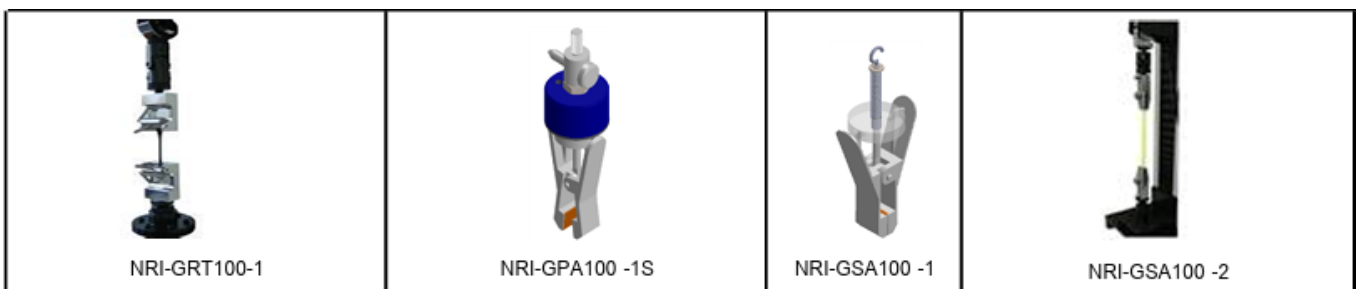

Peeling fixtures

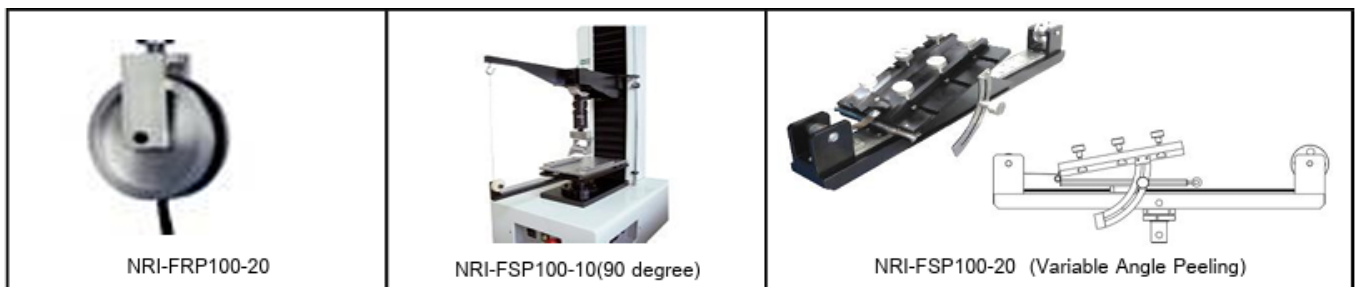

Universal Testing Machine

Portable vehicle scales

Screw type parallel jaw grip

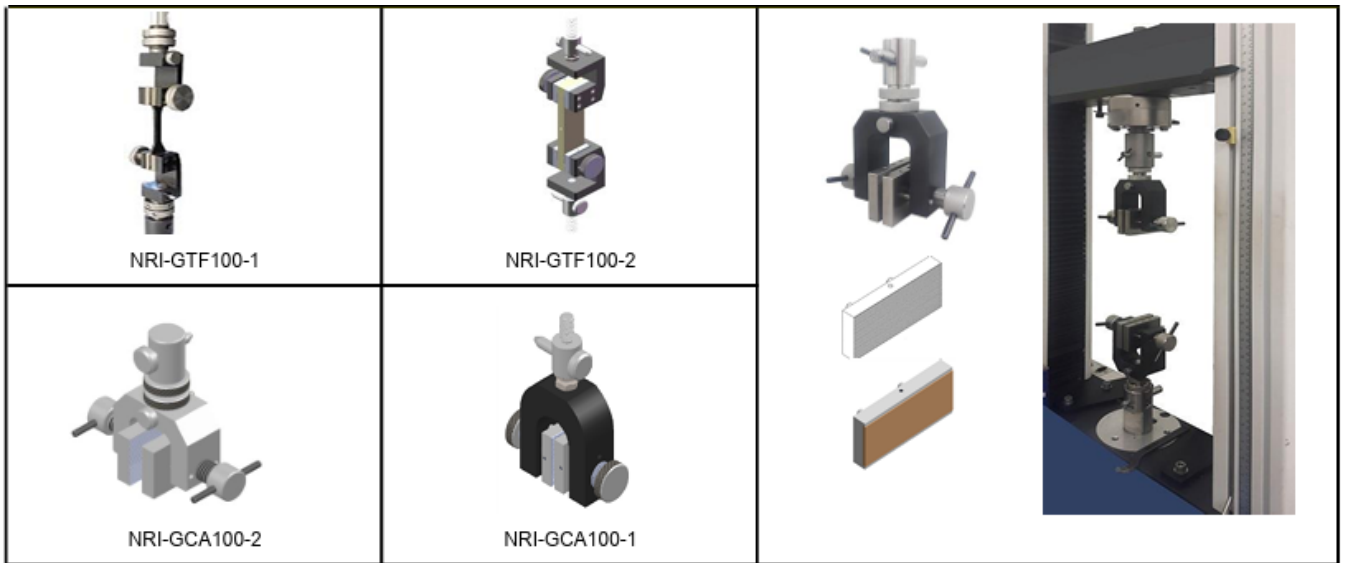

Wire & cord grip





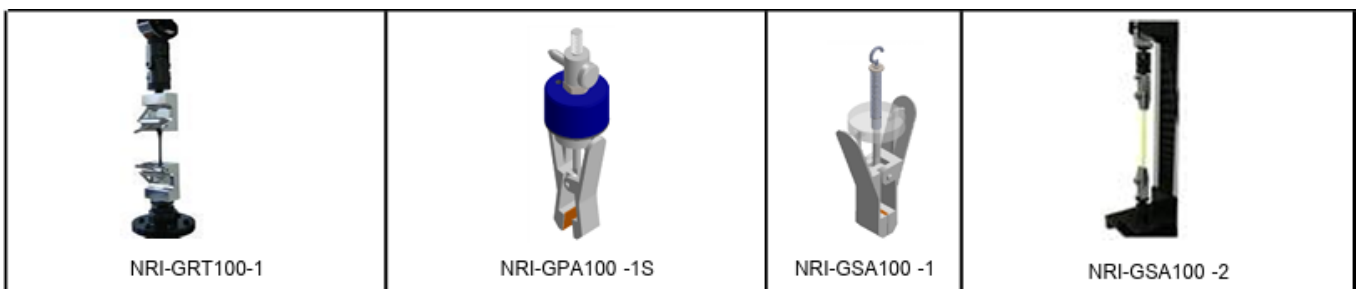



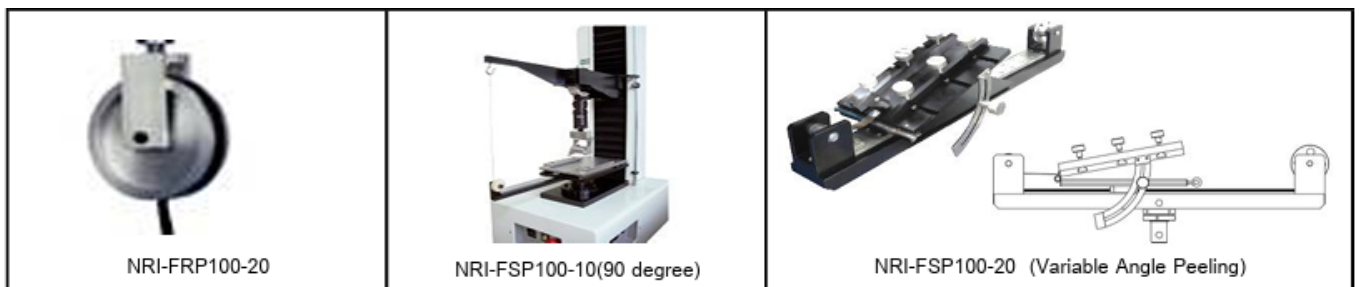

Rubber & Plastic grip

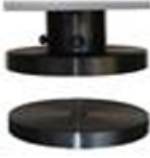

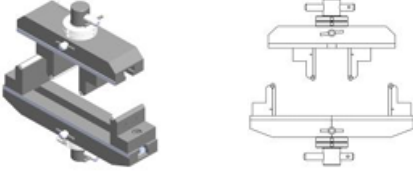

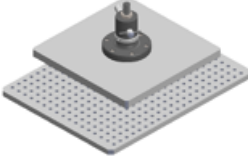

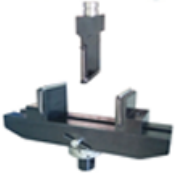
Peeling fixtures

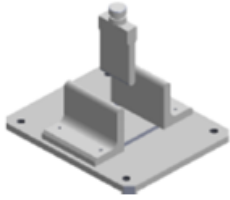
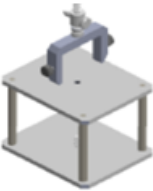

Compression & Bending test fixtures

 <p>Compression plate 300-600kN NRI-FCT100-500</p>	 <p>Ball-Joint compression NRI-FCT100-100</p>	 <p>4-Point bending fixtures NRI-FPT100-100</p>
 <p>Foam compression test(Ball Joint) NRI-FCT100-10</p>	 <p>Foam compression test(Ball Joint) NRI-FCT100-20</p>	
 <p>NRI-TPF100-100</p>	 <p>NRI-TPF100-500</p>	

Food Texture Fixtures

 <p>3-point bending</p>	 <p>Dairy Testing Fixture</p>	
 <p>Compression set</p>	 <p>Knife prove test</p>	

Universal Testing Machine

Other Jig & fixture







Jig & fixture

 <p>Spring tension & compression</p>	 <p>Briquet tensile test grip (NRI-BTG100-50)</p>	 <p>Self-aligning tension : threaded & shouldered</p> <p>NRI-BTG-50 NRI-BTG-100 NRI-BTG-300</p>
 <p>Hydraulic grip NRI-HPA100-300</p>	 <p>Shear test fixture 100.373 NRI-STF 100-10</p>	 <p>Loop tack fixtures NRI-LTT100-20</p>
 <p>Plunger test fixture</p>	 <p>Tire plunger test fixture</p>	 <p>O-Ring tensile grips</p>
 <p>Compression test of welds</p>	 <p>Joint pullout fixture</p>	 <p>Tuft clamp and Tufts for testing</p>

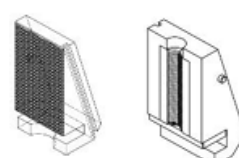
Universal Testing Machine

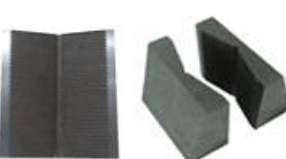
Special accessories

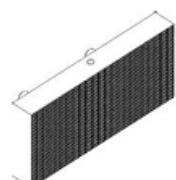
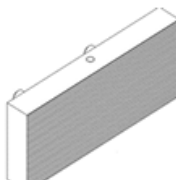
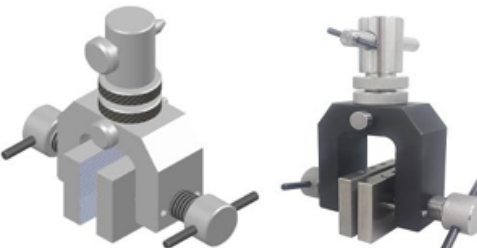
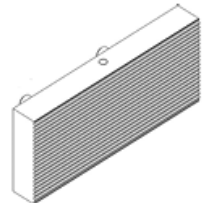
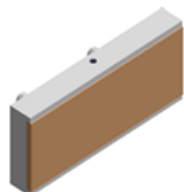
Tension teeth

 <p>NRI-TG-0050</p>	 <p>NRI-TG-0100</p>	 <p>NRI-TG-0300</p>
 <p>For pipes</p>	 <p>NRI-TG-0500</p>	 <p>NRI-TG-1000</p>
 <p>Crosshatch faced jaws</p>	 <p>Fine serrated faced jaws</p>	
 <p>Corrugated jaws</p>	 <p>Rubber faced jaws</p>	 <p>Salt spray nozzle(NRI-CCT-01)</p>

Universal Testing Machine

Special accessories

Portable vehicle scales

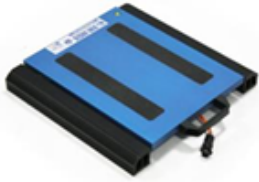

Wheel weighing Model : WWSB

Platform (mm) 900 x 500 : 6, 10, 15, 20 ton

Platform (mm) 900 x 700 : 10, 15 ton



Mobile axle weighing 20ton/10kg : Model : WWSLEK20T : 20 ton

Dimensions: 700 x 561 mm. Height 58 mm

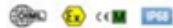
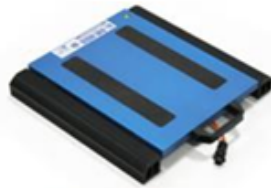

Wheel weighing Model : WWSB

Platform (mm) 400 x 300 : 1.5, 3, 6, 8 ton

Platform (mm) 500 x 400 : 1.5, 3, 6, 8, 10, 15 ton

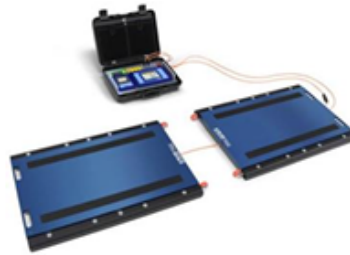

Mobile axle weighing 30ton/10kg : Model : WWSEK30

Each platform weighing area 450 x 700mm

